

1.8m HIGH 358 FLAT BEAM PRISON MESH WITH 60x60mm DIG IN BAY

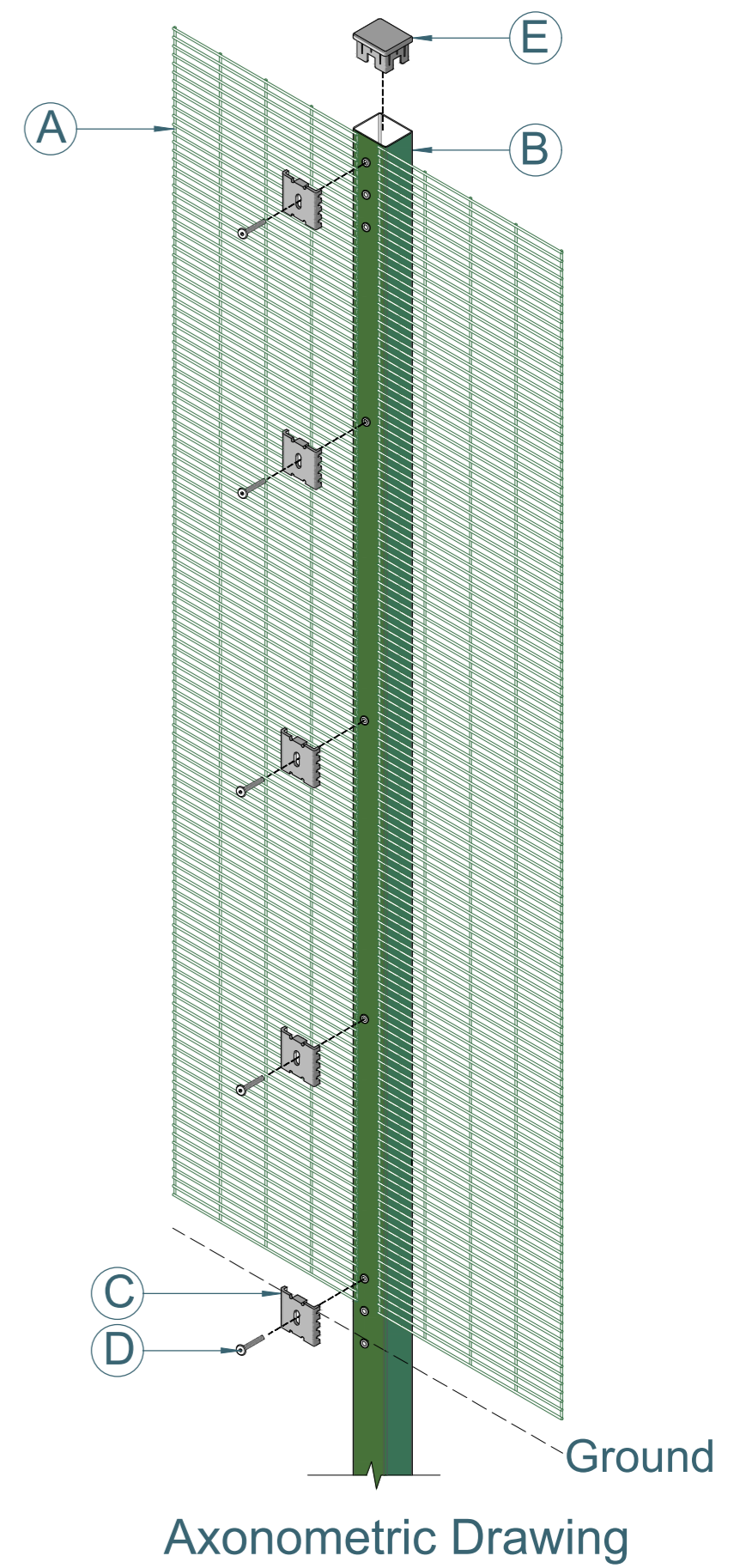
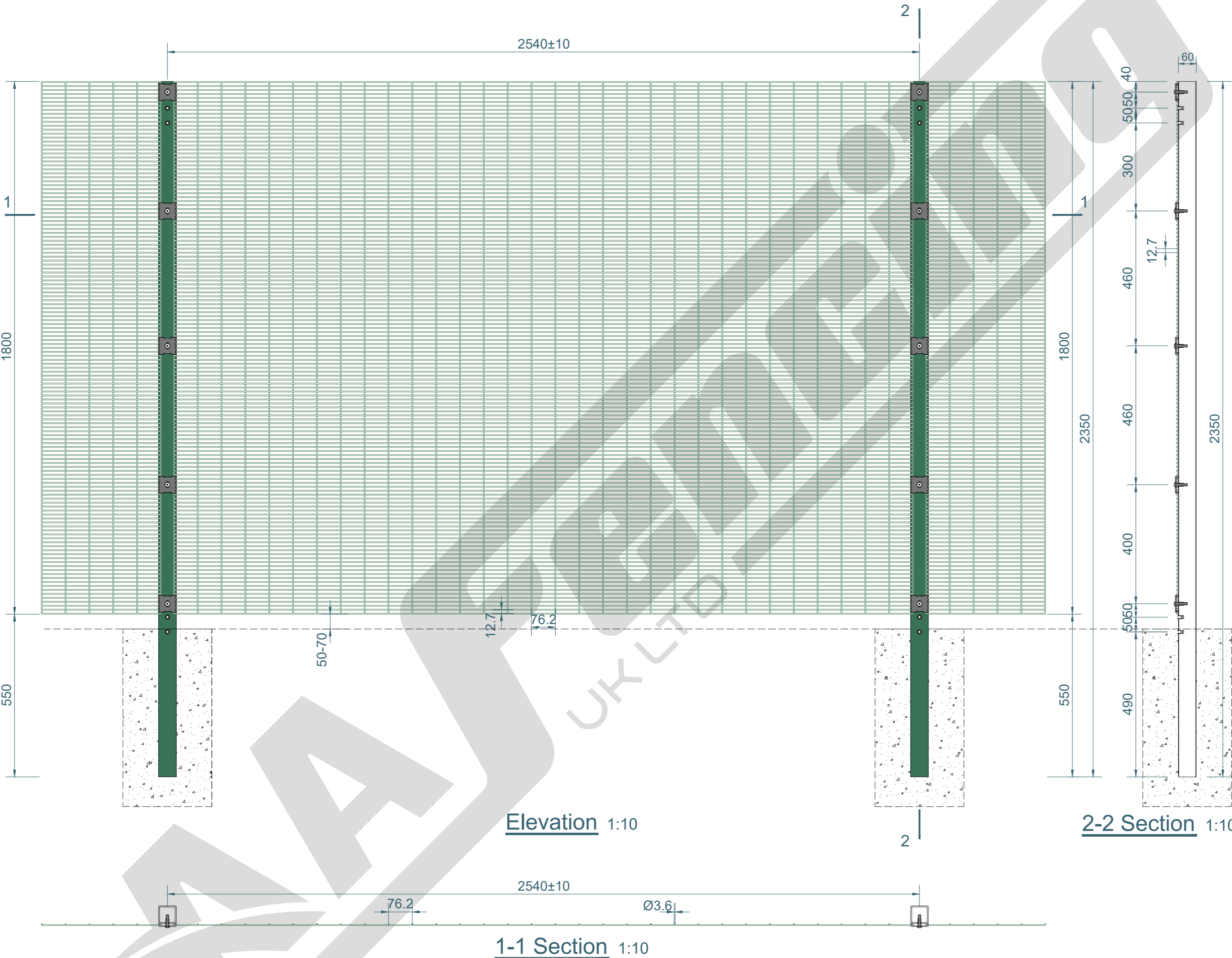

ITEM	PARTS NAME	QUANTITY
A	MESH - 1.8m HIGH 358 FLAT BEAM PRISON MESH PANEL ONLY	1
B	POST – 2.35m HIGH 60x60mm DIG IN POST ONLY	1
C	UNIVERSAL FIXING CLIP	5
D	M8x40mm MESH SECURITY INSERT BOLT	5
E	60x60mm BLACK CAP	1

TITLE: 1.8m HIGH 358 FLAT BEAM PRISON MESH WITH 60x60mm DIG IN BAY
 AA Fencing UK Ltd. The Wireworks Evans
 Road, Speke Liverpool L24 9PB
 0151 363 1234 info@aafencing.co.uk

SIZE: A2 RVE: 1.0 DRAWN: W.CY DATE: 15/03/2025
 SCALE: 1:10
 WEIGHT: PANEL 31kg, POST 6.8kg
 SHEET 1 OF 3

NOTE: SHOULD ANY DISCREPANCIES BE FOUND WITH THIS DRAWING, PLEASE INFORM AA FENCING. COPYRIGHT OF THIS DRAWING IS OWNED BY AA FENCING UK LIMITED



1.8m HIGH 60x60mm INTERMEDIATE DIG IN POST ONLY(AL2350mm)

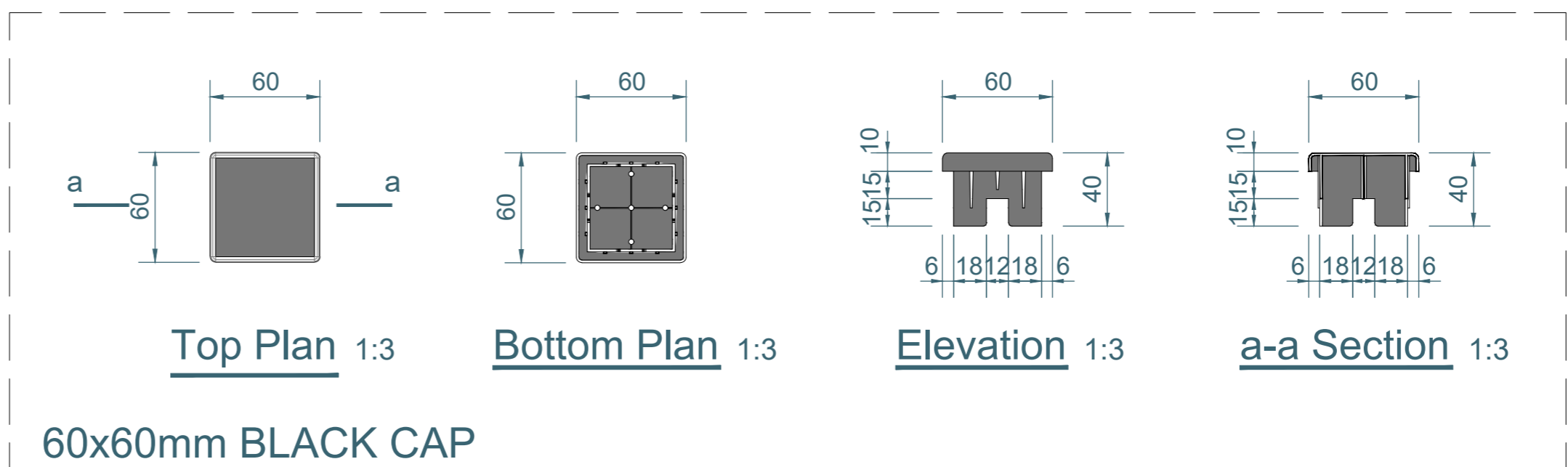
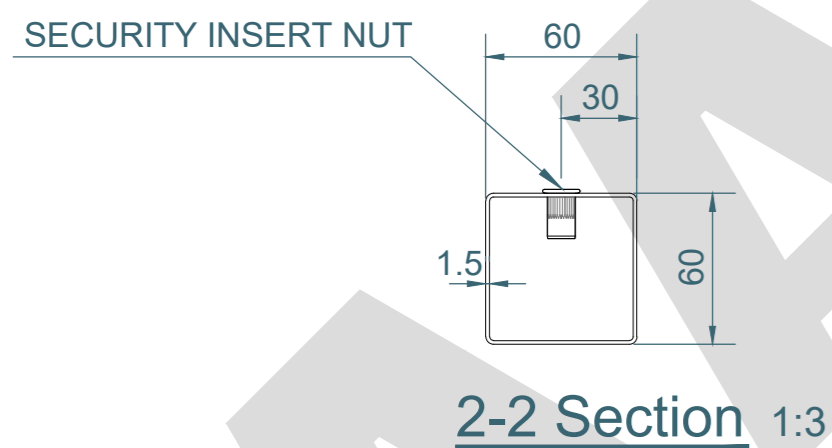
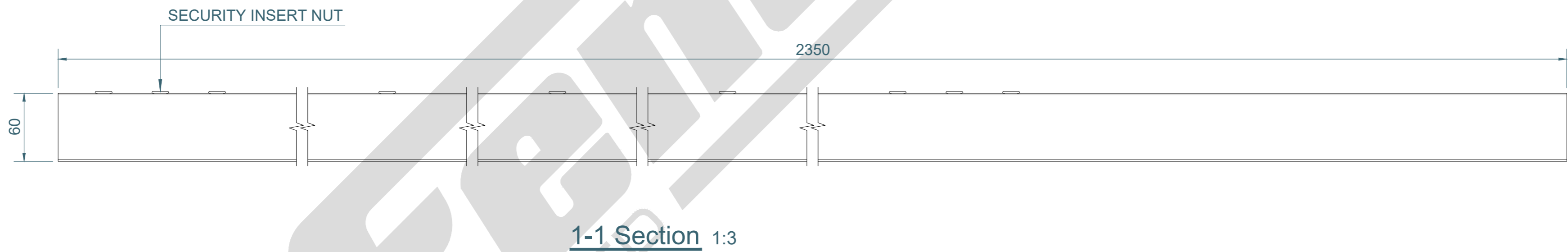
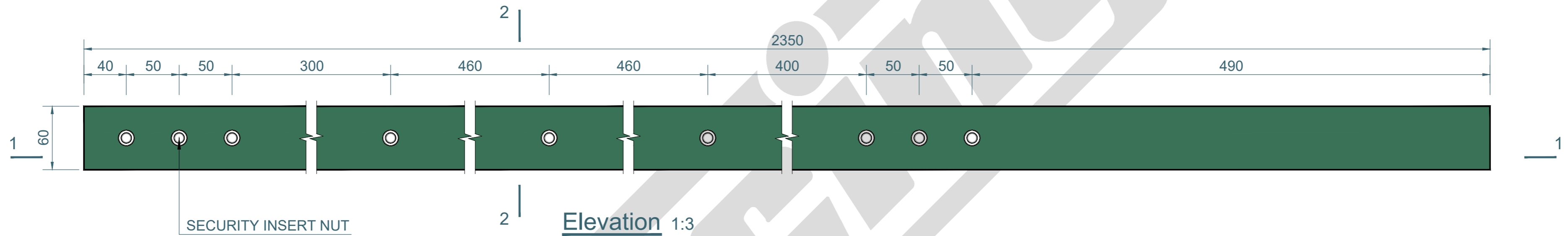

TITLE: 1.8m HIGH 60x60mm INTERMEDIATE DIG IN POST ONLY(AL2350mm)

AA Fencing UK Ltd. The Wireworks Evans
Road, Speke Liverpool L24 9PB
0151 363 1234 info@aafencing.co.uk



SIZE: A2 RVE: 1.0 DRAWN: W.CY DATE: 15/03/2025

WEIGHT: POST 6.8kg

SCALE: 1:3

SHEET 2 OF 3

NOTE: SHOULD ANY DISCREPANCIES BE FOUND WITH THIS DRAWING, PLEASE INFORM AA FENCING. COPYRIGHT OF THIS DRAWING IS OWNED BY AA FENCING UK LIMITED

FLAT BEAM PRISON MESH FITTINGS

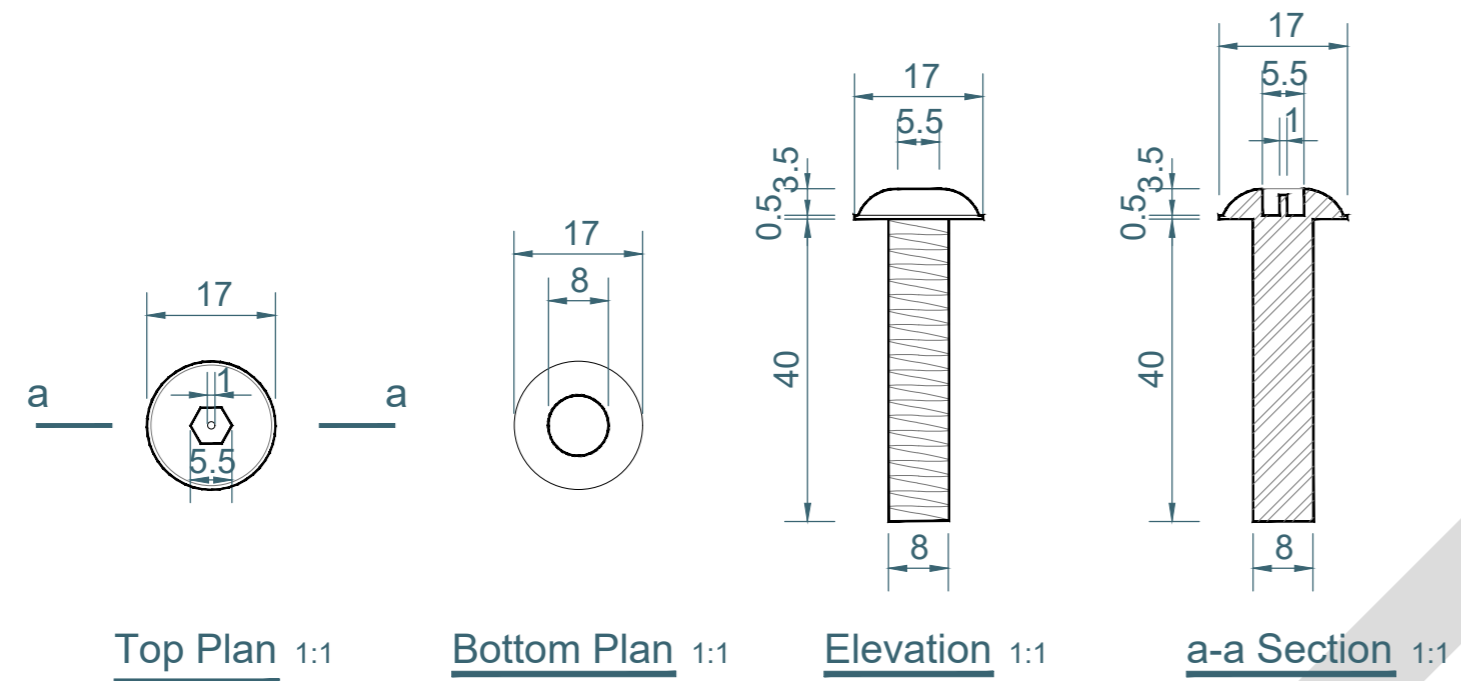

M8x40mm MESH SECURITY INSERT BOLT

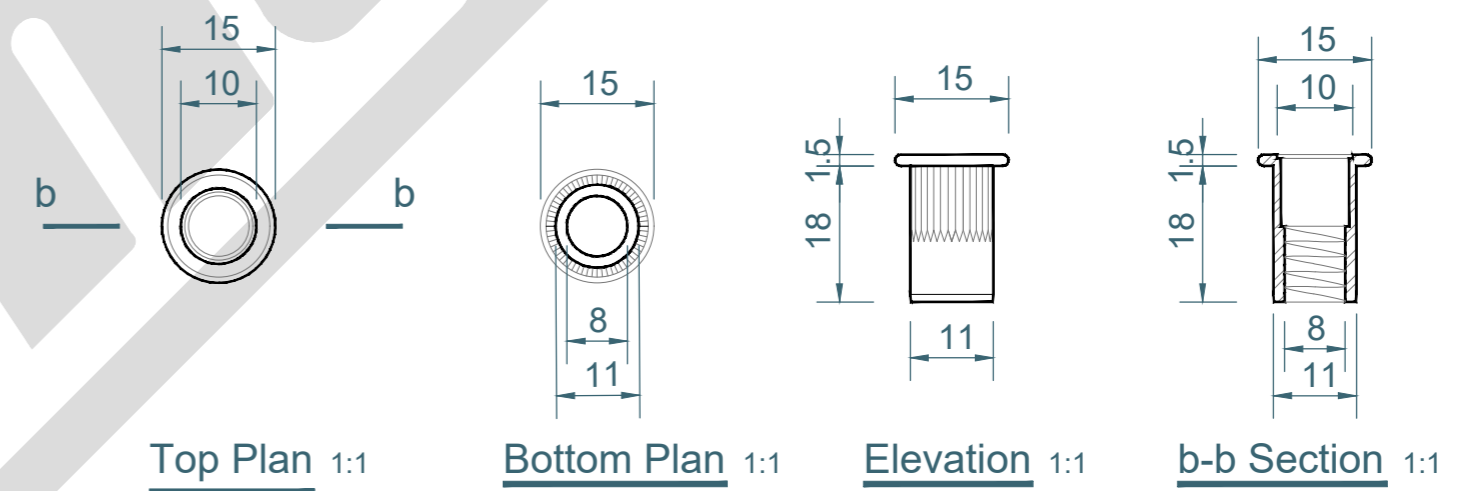

SECURITY INSERT NUT

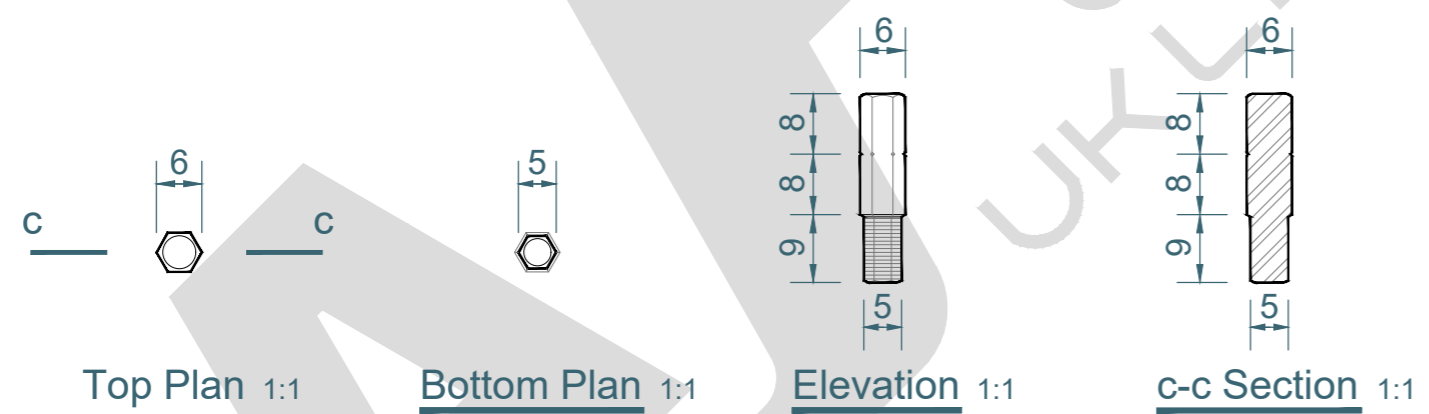

SECURITY KEY

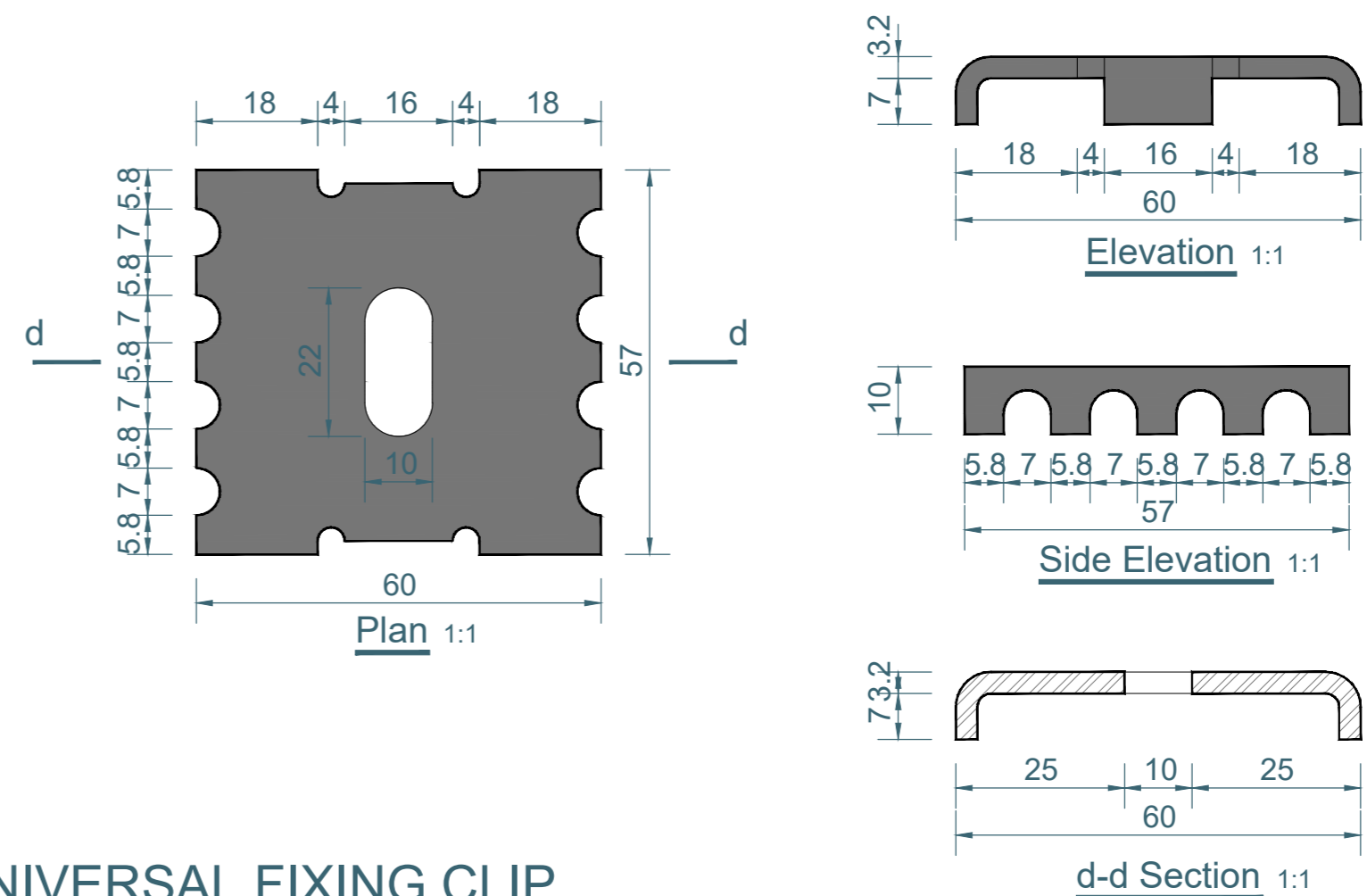

UNIVERSAL FIXING CLIP

TITLE: FLAT BEAM PRISON MESH FITTINGS

AA Fencing UK Ltd. The Wireworks Evans
Road, Speke Liverpool L24 9PB
0151 363 1234 info@aafencing.co.uk



SIZE:

A2

RVE:

1.0

DRAWN:

W.CY

DATE:

15/03/2025

SCALE:

1:1

WEIGHT: POST 6.8kg

SHEET 3 OF 3

NOTE:

SHOULD ANY DISCREPANCIES BE FOUND WITH THIS DRAWING, PLEASE INFORM AA FENCING. COPYRIGHT OF THIS DRAWING IS OWNED BY AA FENCING UK LIMITED